

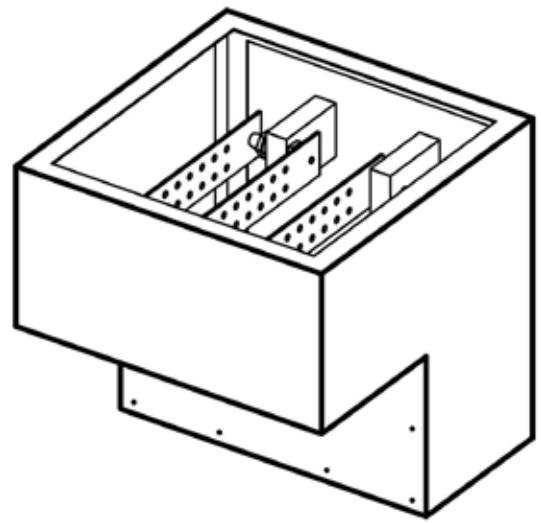

ENCLOSURES
& ENGINEERING



Serving our industry proudly for 55 years!



Standard Sizes

Width	Height	Length	Amps
30	30	15	800
30	30	15	1000
30	30	15	1200
30	30	15	1600
30	30	15	2000
30	30	15	2500
30	30	15	3000
30	30	15	4000

NOTE: All Bussed Products require an EPI engineering drawing engineering drawing when placing an order.

NEMA 3R Bussed Weather Head

Application

EPI NEMA 3R 3-Phase Bussed Weather Head is designed to provide a main entry service drop. These weather heads produce Ampacity ranges from 600 to 4,000 amps at 600 volts, single or three phase. Custom sizes and amperages are available.

Construction

Made from 14-gauge steel. All seams are continuously welded. There are no holes or knockouts. The covers are gasketed and held with self-tapping screws. Available in Aluminum and Stainless Steel.

Buss Bars

C110 Silver Plated Copper is used and buss bars are sized according to one square inch of copper bus per 1000 Amps per N.E.C. article 366.23(A). Buss bars are insulated with 3" 600 volt standoff insulators. Horizontal Buss Bars only. Bars are punched with 9/16" holes at 1 3/4" each way to accommodate lugs.

Finish

The standard finish is Sherwin Williams ANSI-70, light-dove gray enamel, inside and out.

Industry Standard

Meets National Electrical Manufacturers Association (NEMA) standard for Type 3R (Rainproof and Sleet-Ice Resistant) enclosures.